

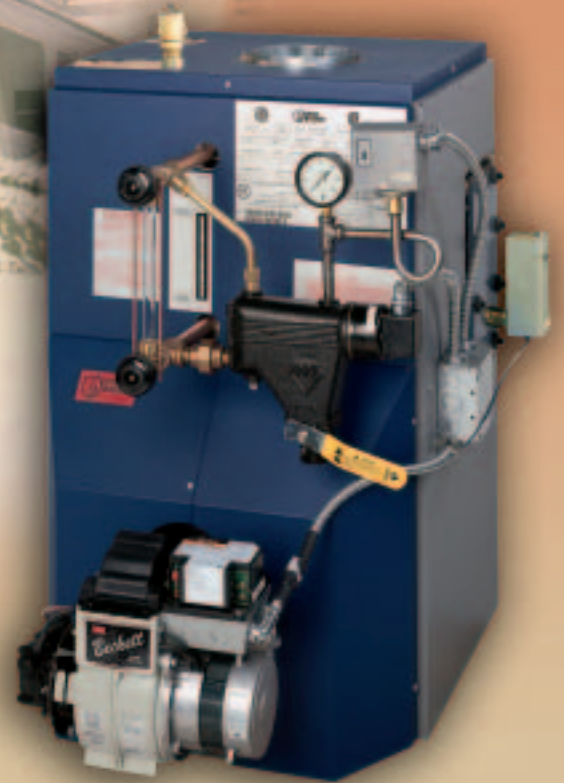

Cast Iron Oil-Fired Steam Boiler

Quality Engineered for Efficiency and Dependability

Starfire III



 **UTICA
BOILERS**
The Heat is ON!

Starfire III
Oil-Fired/Steam

Optimal Efficiency & Operation for Homes Heated With Oil

The Starfire III oil-fired steam boiler delivers high efficiency, reliability and ease of maintenance for homes requiring oil fired heat. A smart design combined with quality components result in lower operating costs making the Starfire III an ideal replacement choice.

High Efficiency Ratings

With efficiencies up to 84% AFUE, the Starfire III provides increased energy savings resulting in lower fuel bills. The boiler's wet-base design helps overall efficiency by enclosing the combustion chamber with water on five sides therefore maximizing heat transfer. With the potential cost savings this represents, the Starfire III will pay for itself in a few short years.

Cast-Iron Sections and Push Nipples

The Starfire III utilizes cast-iron construction because of its durability and efficient heat transfer capabilities. Cast iron sections and push nipples are utilized to construct the heat exchanger. Using only the highest quality cast-iron and heat transfer designs, the Starfire III will provide many years of efficient and trouble-free operation.



Easy Access & Maintenance

A sturdy cast-iron swing door allows for quick and easy inspection of the oil burner and combustion area while extra large flue ways allow for easy cleaning and set-ups. These flue way openings are easily accessed through an integrated two-part draft hood. All components are easy to reach, greatly reducing the time spent on regular maintenance and service calls.

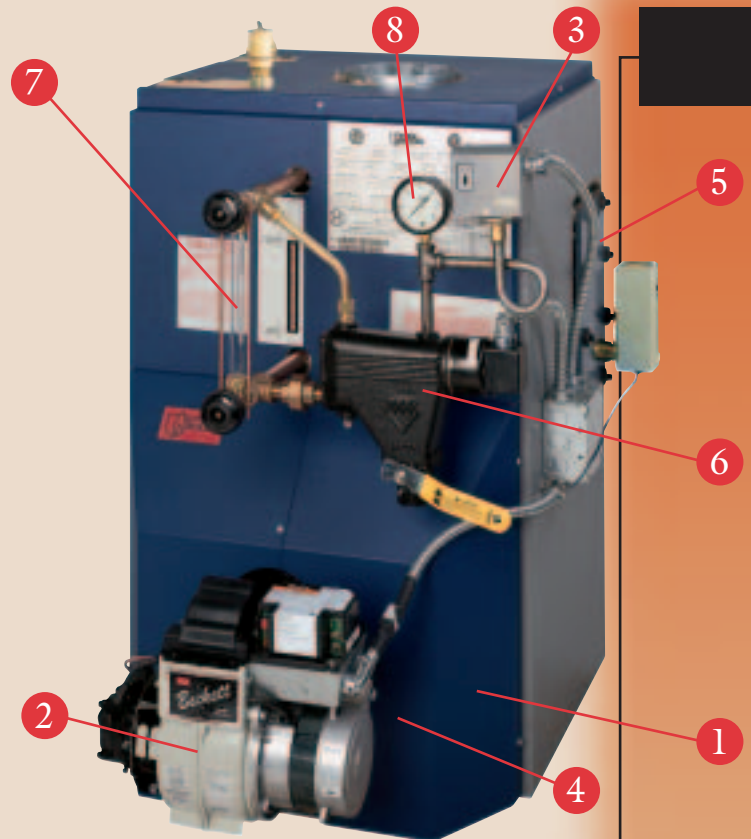

High-Performance Burner Versatility

The Starfire III is designed to accommodate various oil burners. Choose manufacturer approved burners from Beckett, Carlin or Riello.

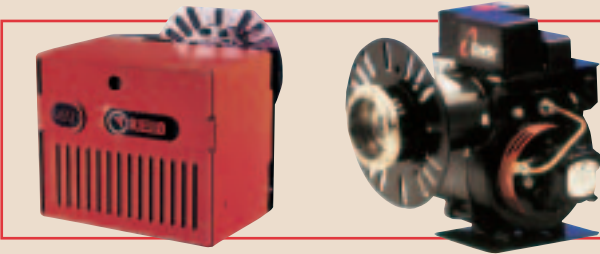

Integral Skim Tapping

An integral skim tapping was added to simplify the mechanics of this basic service function. Periodic skimming, is advantageous to trouble-free operation and Utica has provided a pre-threaded outlet to simplify this maintenance procedure.



Tankless Water Heater Option

An optional tankless hot water coil is offered with the Starfire III. It features off-set tapplings to speed installation and service. Used with a flow control and tempering valve, this tankless heater is an ideal method of providing domestic hot water for most installations.

Factory Pre-Wired & Tested

Each Starfire III Boiler is shipped with controls pre-wired and is subjected to a series of rigorous quality assurance tests to provide quick and easy setup in the field.

Starfire III Boiler Details.

- 1 Cast-Iron Heat Exchanger
- 2 Quality Burner Options
- 3 Steam Pressure Control
- 4 Cast-Iron Swing Door
- 5 Optional Tankless Water Heater
- 6 Low Water Cut-Off
- 7 Water Sight Glass
- 8 Pressure Gage

Key Starfire III Features

- Efficiencies up to 84% AFUE
- Cast-Iron Heat Exchanger and Swing Door
- Recessed Target Wall
- Large Flueway Opening
- Special burner mounting plate increases combustion chamber
- Cast Iron Sections and Push Nipples
- Tankless heater option
- Wide range of sizes to fit residential and light commercial applications

Starfire III

SFH-S & ST Series

Ratings and Data

BOILER MODEL NUMBER ¹	I = B = R OIL BURNER INPUT ^{2,5}		D.O.E. HEATING CAPACITY MBH ⁵	STEAM MBH	I = B = R NET RATINGS ^{3,5}		PUMP PRESS. PSI	NOZZLE FURNISHED 140 PSIG	A.F.U.E. RATING
	G.P.H.	MBH			SQ. FT. STEAM	WATER MBH			
SFH-365S	0.65	91	78	59	246	68.0	140	.60 80°B	84.00
SFH-3100S	1.00	140	116	87	363	101.0	140	.85 80°B	81.50
SFH-4125S	1.25	175	145	109	454	126.0	140	1.10 80°B	82.50
SFH-4150S	1.50	210	170	128	533	148.0	140	1.25 80°B	81.00
SFH-5175S	1.75	245	202	152	633	176.0	140	1.50 80°B H	83.00
SFH-5200S	2.00	280	227	170	708	197.0	140	1.75 70°B H	82.00
SFH-6225S	2.25	315	251	188	783	218.3	140	2.00 45°B	—
SFH-7275S	2.75	385	307	230	958	267.1	140	2.25 45°B	—

Nozzles with an H designation are Hago brand, all others are Delevan.

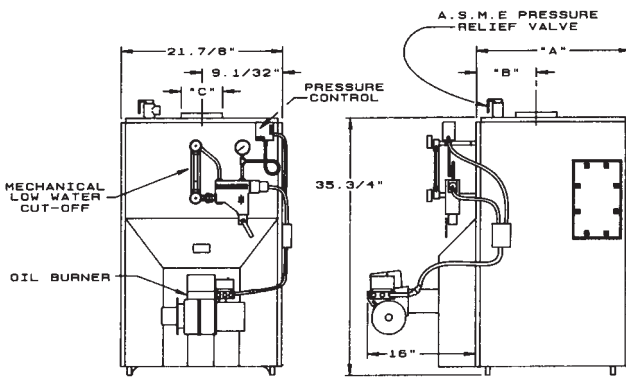

Dimensions

BOILER MODEL NO.	A LENGTH OF FLUSH JACKET	B FRONT OF JACKET TO C/L OF FLUE OUTLET	C DIA. OF FLUE OUTLET
SFH-3S	16 ³ / ₈	6 ¹ / ₂	6
SFH-4S	20 ¹ / ₄	8 ¹ / ₂	6
SFH-5S	23 ³ / ₈	10 ¹ / ₄	7
SFH-6S	27 ¹ / ₂	8 ⁵ / ₁₆	8
SFH-7S	31 ¹ / ₈	8 ⁵ / ₁₆	8

Notes

1. Add suffix "T" to denote boiler with tankless heater.
2. I=B=R burner capacity is based on an oil heating value of 140,000 Btu/gal. and with 13% CO₂.
3. Net ratings based on heat emission of 240 Btu per square foot per hour and a piping and pick-up allowance of 1.33.
4. Nozzle listed is for use with Beckett AFG burner. When alternate burner is used, consult burner manufacturer's recommendations.
5. Gallons of water per minute heated from 40° to 140° F with 200° boiler water temperature.

STANDARD EQUIPMENT: Crated Cast Iron Boiler, Flush Jacket, Swing-Out Burner Door, Clean Cut AFG Beckett Oil Burner, Target Wall/Liner, ASME Relief Valve, Steam Water Level Gauge, Steam Pressure Gauge, Steam Pressure Control, Mechanical Low-Water Cut-Off, Drain Cock, Wiring Harness, Burner Electric Disconnect, Plastic Cover, Supply Tapping (Qty. 2 - 2"), Return Tapping - 1/2" and Primary Control. For Tankless Heater Units Add: Tankless Hot Water Coil, Flow Restrictor and Limit Control. Note: 1/2" Coil Tappings on All Models.

(Specifications and dimensions are subject to change without notice)

MEA# 182-86E

Tankless Water Heater Capacities

BOILER MODEL NUMBER	TANKLESS HEATER NUMBER	TANKLESS HEATER CAPACITY INTERMITTENT DRAW G.P.M. ⁵	BOILER WATER CONTENT GALS.
SFH-365S	L-24	Available on Request	11
SFH-3100S	L-24	4.5	11
SFH-4125S	L-24	4.5	13
SFH-4150S	L-24	4.5	13
SFH-5175S	L-24	5.0	15
SFH-5200S	L-24	5.0	15
SFH-6225S	L-24	5.0	17
SFH-7275S	L-24	5.0	19

Your Assurance Of Quality

Utica Boilers products are designed, tested, and assembled to ensure that you get the very best in home heating and cooling comfort, and value. Each one meets or exceeds all recognized safety, performance and efficiency standards.

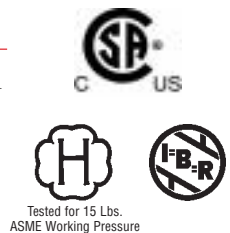

**USA Homeowner Assistance:
866-847-6656**

**USA Contractor Assistance:
800-325-5479**

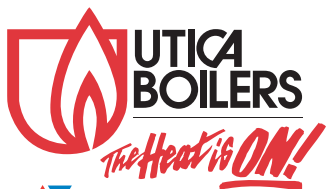

An ECR International Brand

P.O. Box 4729 • Utica, New York 13504
Tel. 315-797-1310 • Fax 866-432-7329
Web Site: www.utica boilers.com
E-mail: sales@utica boilers.com

An ISO 9001-2000 Certified Company

For more information on Utica Boilers heating products contact your local distributor or call Utica Boilers Customer Service Department at 1-800-325-5479.

Part No: 240005088 1/07