



Utica Boilers MAH-125 - Submittal

Engineer: _____

Project Name: _____

Project Location: _____

Contractor: _____

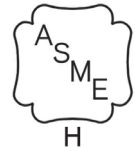

APPLICATION:

Modulating Gas fired water boiler for indoor installation. Approved for closet or alcove installations. For use with natural or liquefied petroleum (LP/Propane) fuel gases. Wall mounted – optional floor stand available. All boilers are factory assembled with controls and wiring and test fired to ensure dependable performance. Boiler shall be certified for Direct Vent applications only.

CERTIFICATION AND APPROVALS:

Stainless Steel heat exchanger is manufactured and tested in accordance with American Society of Mechanical Engineers (ASME) and certified by Canadian Standards Association (CSA), AHRI, NRCAN. Registered with National Board BPVI, and Massachusetts Board. Stainless steel heat exchanger is tested for maximum allowable working pressure of 50 psig in accordance with ASME boiler and pressure vessel code, section IV, rules for construction of heating boilers. A 30 psig safety relief valve is shipped standard.

BOILERS INCLUDE:

- Wall mount bracket, mounting hardware and actual size Wall Mount Template
- Boiler is equipped with dedicated connection to an optional Indirect hot water tank and an internal automatic 3 way diverting valve to allow Domestic Hot Water Priority operation.
- Boiler includes factory installed and wired 2 speed circulator pump.
- External Primary/Secondary manifold with quick connections shipped with boiler.
- Digital Boiler Control:
 - ▶ Control is self-commissioning, automatically recognizing fuel type (Natural or LP gas).
 - ▶ Control continuously monitors flame signal and automatically adjusts the gas valve during normal operation for optimum combustion and maximum efficiency.
 - ▶ Control system is PCB integral controller with LCD digital/graphical display.
 - ▶ Control can sense and display water temperature and indicate when boiler is in central heating or domestic water mode.
 - ▶ Control can accept an optional Outdoor Air sensor and has field adjustable reset curves.
 - ▶ Control displays Error Codes and Diagnostic information.
 - ▶ Control can accept 0-10V input to manage heating set-point or heating power level.



ECR international

Manufactured by:
ECR International Inc.
2201 Dwyer Avenue, Utica, NY 13501
Tel. 800 325 5479
www.ecrinternational.com
PN 240011521 REV. F [10/15/2021]



- Boiler Combustion System:
 - ▶ The Gas valve is a modulating valve capable of firing from 125,000 BTU input down to 22,000 BTU input in Heat mode (5.7:1 turn down).
 - ▶ Induced draft blower is variable speed controlled by the PCB.
 - ▶ Burner is constructed of Iron- Chromium stainless steel.
 - ▶ Ignition system shall incorporate a Direct Spark Igniter and a separate Flame Sensing rod.

- Heat Exchanger:
 - ▶ Boiler's primary heat exchanger is constructed of Iron- Chromium stainless steel.

- Electrical
 - ▶ 120 volts AC, 60 Hertz, 1-phase; less than 15 amps.
 - ▶ Factory wired 3-foot appliance cord with male plug end.
 - ▶ Low voltage terminal strip for Thermostat, Outdoor Air Sensor, Indirect Tank sensor.

- Warranty
 - ▶ Factory Standard Warranty is 10 years on heat exchanger, one year on parts.
 - ▶ Warranty is extended to 10 years on heat exchanger, two years parts plus two years labor upon online warranty registration and completion of contractor registration.

- Optional Equipment
 - ▶ Outdoor Air Sensor Kit
 - ▶ Indirect Tank Sensor Kit
 - ▶ Coaxial and Two-pipe venting components





					
Size	Boiler Input Rate (MBH) ⁽¹⁾		Heating Capacity (MBH) ⁽¹⁾⁽²⁾	Net AHRI Rating, Water (MBH) ⁽¹⁾⁽³⁾	AFUE ⁽²⁾
	Maximum	Minimum			
MAH-125	125	22	113	98	95.0

⁽¹⁾1000 Btu/hr (British Thermal Units Per Hour)
⁽²⁾Heating Capacity and AFUE (Annual Fuel Utilization Efficiency) are based on DOE (Department of Energy) test procedures.
⁽³⁾Net AHRI Ratings based on piping and pickup allowance of 1.15. Contact Technical Support before selecting boiler for installations having unusual piping and pickup requirements, such as intermittent system operation, extensive piping systems, etc.
 *Max CH Supply temp 176° F (80°C) for MAH-125 *Max DHW temp 140° F (60° C)

MAH-125	
Minimum Clearances for Servicing	
Top	8.66 in / 220.00 mm
Bottom	9.84 in / 250.00 mm
Sides	1.77 in / 45.00 mm
Front	17.71 in / 450.00 mm
Flue Terminal Size Concentric System	3.93 in / 100.00 mm
Flue Terminal Size 2-Pipe Flue System	3.14 in / 80.00 mm
Flue Terminal Protruding	4.52 in / 115.00 mm

MAH-125	
Central Heating (Sealed System)	
Max System Pressure	43.00 psi / 2.96 bar
Min System Pressure	7.25 psi / 0.50 bar
Max System Temperature	176°F / 80°C
Pressure Relief Valve Setting	30.00 psi / 2.11 bar
Flow Connection	1¼" / 31.8 mm Copper Stub
Return Connection	1¼" / 31.8 mm Copper Stub
Relief Valve Connection	3/4" / 22.2 mm NPT
Recommended Operating System Pressure	21.7 psi / 1.5 bar



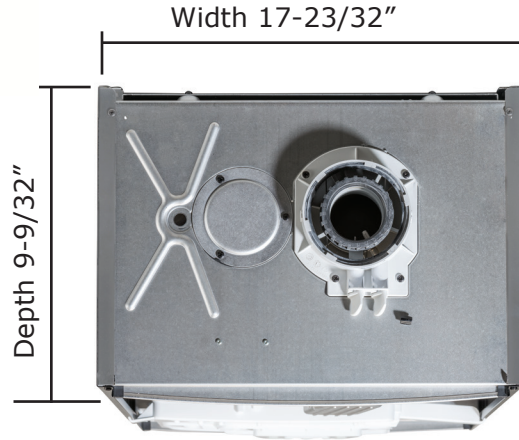

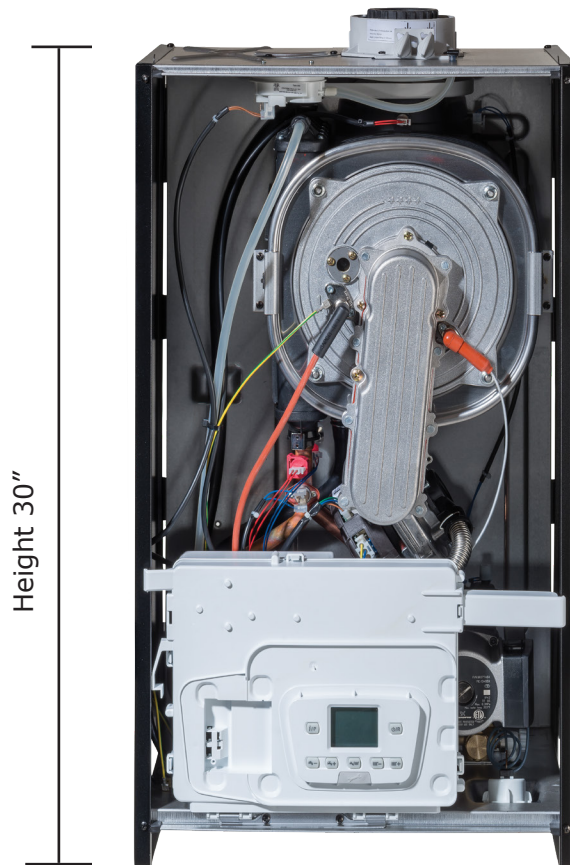

View - Front of Boiler



Manufactured by:
ECR International Inc.
2201 Dwyer Avenue, Utica, NY 13501
Tel. 800 325 5479
www.ecrinternational.com
PN 240011521 REV. F [10/15/2021]

Venting

<p>Coaxial Venting Connects directly to the top of the boiler</p> 
<p>2-Pipe Venting - Optional Kit Using polypropylene - 80 mm venting</p> 
<p>2-Pipe Venting - Optional Kit Using CPVC UL1738/S626 - 3" venting</p> 

Total Vent Equivalent Lengths* - Account For Fittings As Listed					
Vent Size	Coaxial	Twin Pipe			
		Rigid		Flexible	CPVC UL1738/ S636
	4"/2" [100/60]	3" [80 mm]	2" ** [60 mm]	3" [80 mm]	3" [80 mm]
Total Maximum	32.8 ft [10 m]				
Air Intake Maximum		49 ft [15 m]	85 ft [25.9 m]	50 ft [15.2 m]	49 ft [15 m]
Intake + Exhaust		196.8 ft [60 m]	170 ft [51.8 m]	130 ft [40 m]	196.8 ft [60 m]
90° elbows	3.28 ft [1.0 m]	1.64ft [0.50 m]	3 ft [0.91 m]	1.64ft [0.50 m]	1.64 ft [0.50 m]
45° elbows	1.64 ft [0.50 m]	0.82 ft [0.25 m]	5 ft [1.5 m]	0.82 ft [0.25m]	0.82 ft [0.25 m]

* Refer to IOM for complete venting details.
 ** Use venting manufacturer's components to transition from 3" [80 mm] to 2" [60 mm]